

ACESSÓRIOS / FERRAGENS

DOBRADIÇAS INOX

Feitos em aço inox , polidas, espessura de 2,5mm.

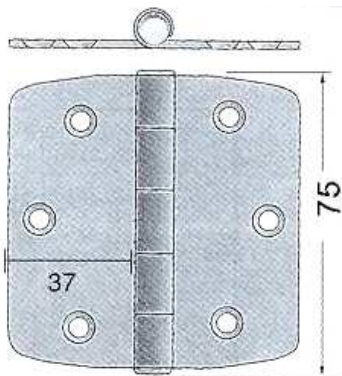

REF: 04-0639

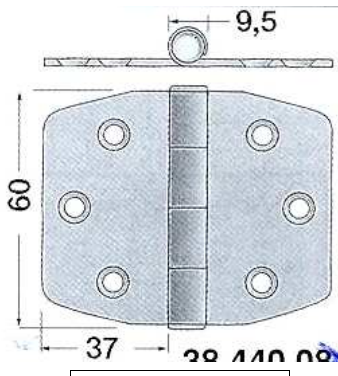

REF: 04-0638

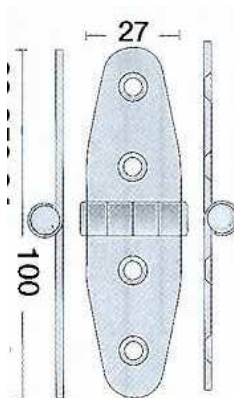

REF: 04-0647

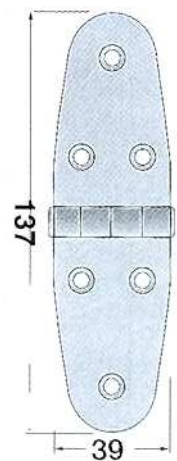

REF: 04-0646

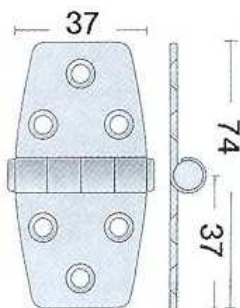

REF: 04-0640

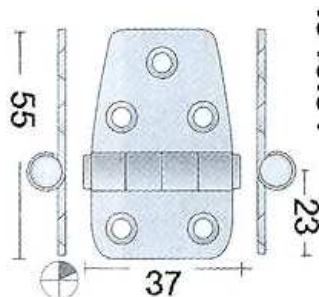

REF: 04-0648

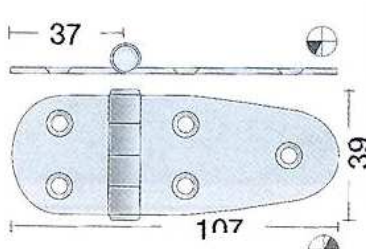

REF: 04-0645

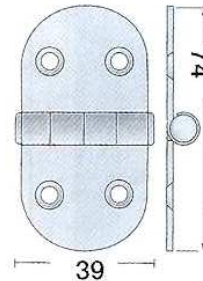

REF: 04-0644

DOBRADIÇAS INOX COM ALTURA

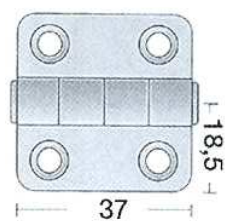

REF: 04-0649

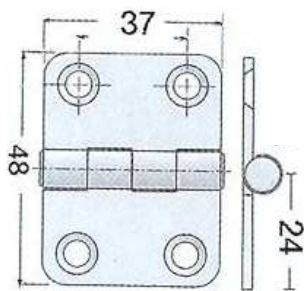

REF: 04-0641

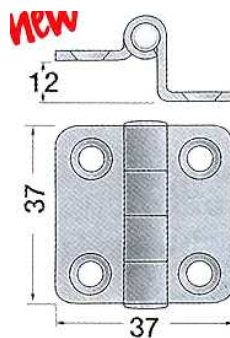

REF: 04-0643

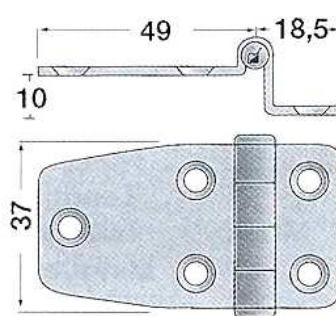

REF: 04-0642

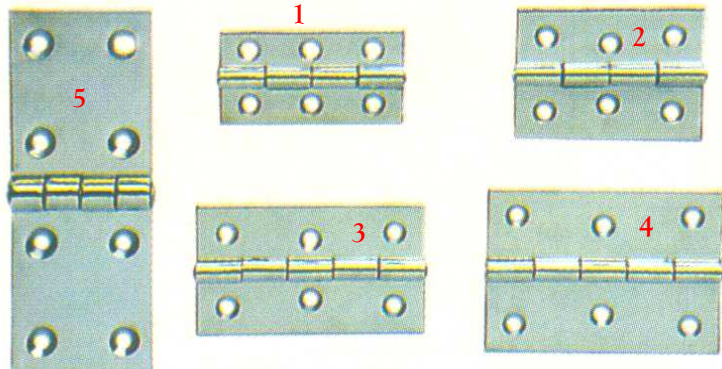

DOBRADIÇAS INOX TIPO PIANO

Feitos em aço inox , polidas, espessura de 1.2mm e 2mm

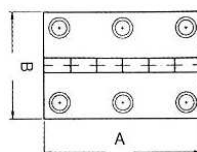

REF:	Nº	(A) MM	(B) MM
04-0650	1	60	30
04-0651	2	60	40
04-0652	3	75	40
04-0653	4	75	50
04-0654	5	45	110

ACESSÓRIOS / FERRAGENS

DOBRADIÇAS INOX PIANO

Feitos em aço inox, polidas, vendido em varas de 2 metros



REF:	COMP.	LARG.	ESPES.
04-0675	2MT	30	0.8
04-0676	2MT	40	1.5
04-0677	2MT	50	1.5

DOBRADIÇAS INOX PARA BANCOS

Feitos em aço inox, 2 posições rebatível e 180°. Vendido aos pares.

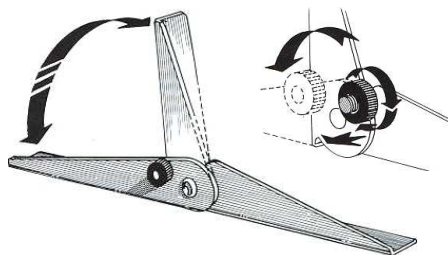

REF:	FECHADA	ABERTA
04-0772	330x60	660x60

DOBRADIÇAS EM NYLON

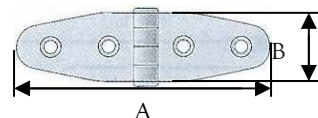
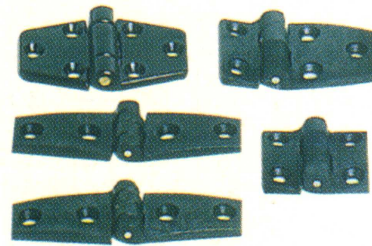

REF:	(A) MM	(B) MM
04-0655	98	65
04-0656	65	40
04-0657	140	33
04-0658	102	30
04-0659	82	26
04-0660	54	38
04-0661	38	38

FECHO INOX

Feito em aço inox, para levar cadeado, sistema fixo.



REF:	TAMANHO
04-0777	52x12

FECHO INOX

Feito em aço inox, para levar cadeado, sistema giratório.



REF:	TAMANHO
04-0774	64x24
04-0775	91x24

FECHO COM PUXADOR EM NYLON

Feito em nylon branco, modelo standard.



REF:	TAMANHO
04-0977	60MM/ DIÂMETRO

FECHO INOX

Feito em aço inox, com fechadura



REF:	TAMANHO
12-2053	76x34

FECHO INOX

Feito em aço inox, fecho de pressão pode levar cadeado.

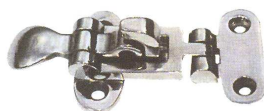

REF:	TAMANHO
04-0629	105x50

FECHO INOX

Feito em aço inox, fecho de pressão com ajuste, pode levar cadeado.

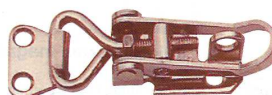

REF:	TAMANHO
04-0904	90x75

FECHO INOX

Feito em aço inox, fecho de pressão pode levar cadeado.



REF:	TAMANHO
04-0891	70x28

FECHO INOX

Feito em aço inox, fecho de pressão de grande robustez pode levar cadeado.



REF:	TAMANHO
04-0903	110x30

FECHO INOX

Feito em aço inox, fecho de pressão.

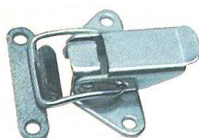

REF:	TAMANHO
04-0891A	52X33

CADEADOS INOX

Interior e olhal em inox, corpo em latão cromado.

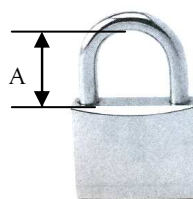

REF:	A
04-3802125	19MM
04-3802130	20MM
04-3802140	26MM
04-3802150	31MM

ACESSÓRIOS / FERRAGENS

PUXADOR COM FECHO

Latão cromado



REF:	TAMANHO
04-0636	57x40

PUXADOR COM FECHO

Latão cromado



REF:	TAMANHO
04-0637	45x42

FECHO

Latão cromado

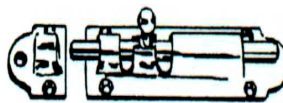

REF:	TAMANHO
04-0890	90x30
04-0890A	105x30

FECHO

Latão cromado



REF:	TAMANHO
04-0783	50
04-0784	80
04-0781	100

ÍMAN TELESCÓPICO P/ PORTA

Íman feito em latão cromado, segura e amortece a porta ao abrir.



REF:	AJUSTÁVEL
04-0988	50 A 82MM

FECHO EM NYLON

Para interiores, fecho com mola.



REF:	04-0782
------	---------

FECHO COM PUXADOR

Para compartimentos interiores, fecho de pressão, latão cromado mod. standard.

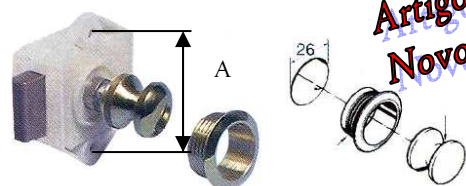

REF:	A	COMPLETO COM PUXADOR
15-3089	38MM	SIM
04-3818001	65MM	NÃO

FECHADURA

Fechadura marítima com interior e ferragens em aço inox, corpo em latão cromado resistente à corrosão, chaves em inox.



REF:	TAMANHO	CANHÃO
	A - B - D - L - L2	
21-	40-42-33-44-29	18MM

FECHO EM NYLON

Para interiores, fecho de pressão.

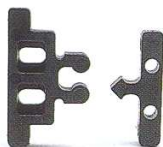

REF:
04-0630

FECHADURA

Fechadura marítima em latão cromado, resistente à corrosão, com várias chapas adicionais para se adaptar às portas.

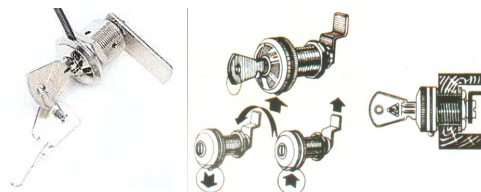

REF:	TAMANHO	CANHÃO
04-0631	16/20/25	16MM

PUXADORES

Latão cromado

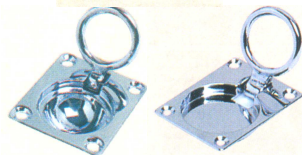
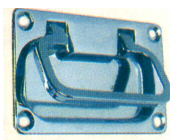

REF:	TAMANHO
04-0889	45x38
04-0889A	65x50
04-0906	75x50

FECHADURA

Fechadura em latão zamack, com chapa e puxador.



REF:	TAMANHO CHAPA	COMP. DO CANHÃO
04-0634	50x55	32

FECHADURA

Fechadura marítima em latão cromado, resistente à corrosão, grande robustez, abre e fecha dos dois lados.

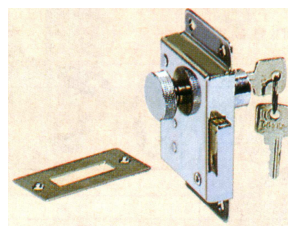

REF:	TAMANHO
04-0633	98x58

FECHADURA

Fechadura marítima em latão cromado, resistente à corrosão, grande robustez.

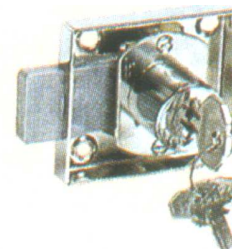

REF:	TAMANHO
04-0632	70x50